

Encasement Ltd
t: +44 (0)1733 266 889
e: sales@encasement.co.uk
w: www.encasement.co.uk

standard specification detail:

type:
pre-formed plywood boiler pipe
work casing

ref: Boiler pipe work casing

thickness: 8mm

length: 495, 2500 or 3000mm

finish: white craft paper

joint detail: N/A

accessories: screws & white caps

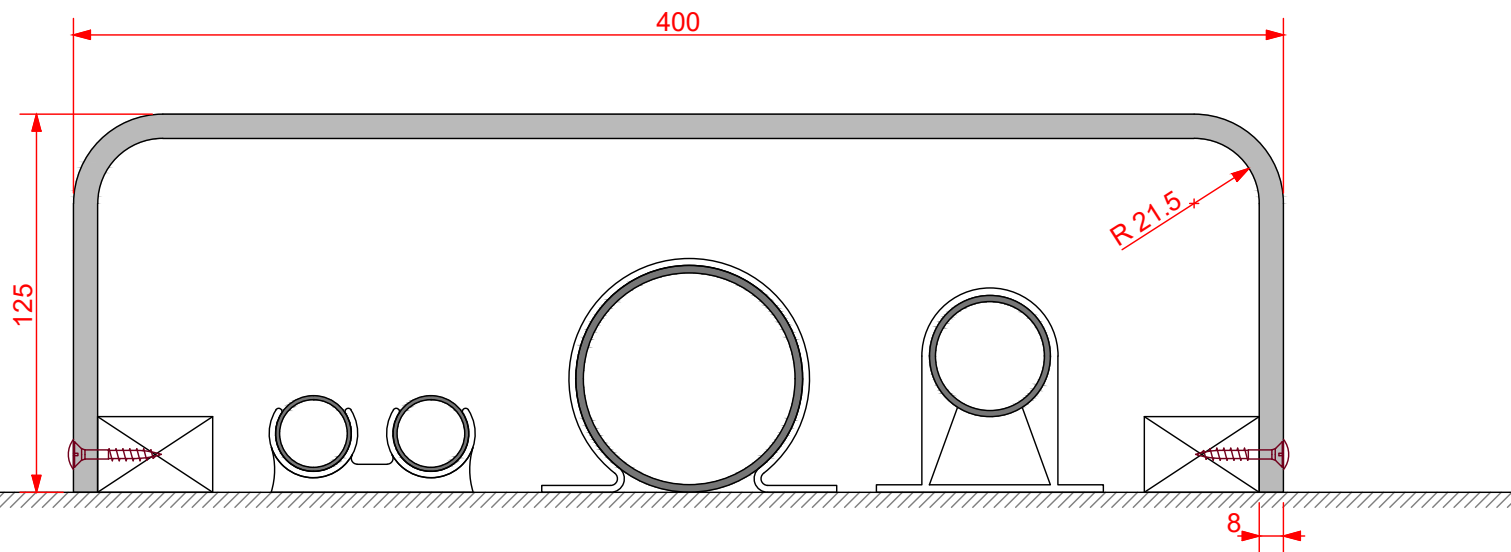

detail:

Boiler Pipe Work Casing
125/400/125mm

date:
JAN 2013

drawn by:
AW

scale:
1:2.5

paper size:
A4

drawing no:

Boiler Pipework Casing
125_400_125.DWG