

Encasement Ltd  
Peartree Business Centre  
Enterprise Way, Bretton, Peterborough  
Cambridgeshire PE3 8YQ  
t: +44 (0)1733 266 889  
f: +44 (0)1733 268 999  
w: www.encasement.co.uk

**standard specification detail:**

type:  
pre-formed aluminium pipe boxing

ref: Arma

thickness: 3mm / 5mm

length: 2400mm

finish: polyester powder coated  
(PPC) or anodised options

joint detail: N/A

accessories: mechanical tamper  
proof fixings are recommended and  
suitable fasteners should be  
sourced separately

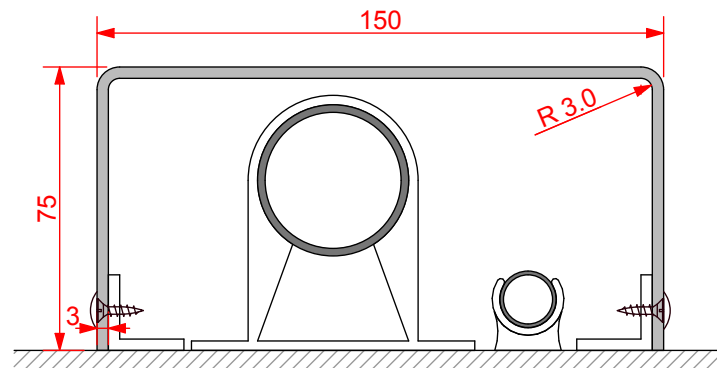

Approx. internal  
working space:  
144 x 72

**detail:**

**Arma External  
Pipe Protection  
75/150/75mm**

date:  
**JAN 2013**

drawn by:  
**AW**

scale:  
**1:2**

paper size:  
**A4**

**drawing no:**

**Arma 75\_150\_75.DWG**