

Encasement Ltd
Peartree Business Centre
Enterprise Way, Bretton, Peterborough
Cambridgeshire PE3 8YQ
t: +44 (0)1733 266 889
f: +44 (0)1733 268 999
w: www.encasement.co.uk

standard specification detail:

type:
pre-formed aluminium pipe boxing

ref: Arma

thickness: 3mm / 5mm

length: 2400mm

finish: polyester powder coated
(PPC) or anodised options

joint detail: N/A

accessories: mechanical tamper
proof fixings are recommended and
suitable fasteners should be
sourced separately

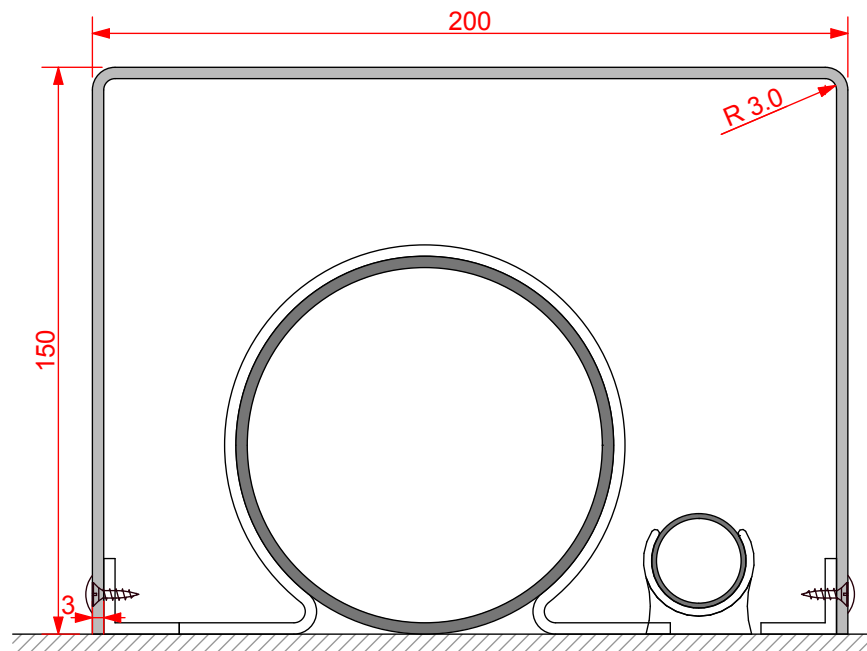

Approx. internal
working space:
194 x 147

detail:

**Arma External
Pipe Protection
150/200/150mm**

date:
JAN 2013

drawn by:
AW

scale:
1:2

paper size:
A4

drawing no:

Arma 150_200_150.DWG